



Q-CAP-D3

INSTALLATION INSTRUCTIONS

NOTE:



- Product should be installed by a qualified electrician.
- For Cabinet Installations:
 - CAUTION: To reduce risk of fires, Do not install in a compartment smaller than 12" x 12" x 12"
- Always test LED operation before installing. Connect LED to power supply to ensure it is working properly.
- Prior to installation ensure power is off at the power supply center to prevent shock.
- Verify LED polarity before power is applied.
- Avoid bending Q-CAP product in sharp angle or against bending design to avoid damage.
- Field modifications are not covered by Q-Tran warranty.
- For installations below 60°F, power the product on and allow it to warm up for 20 minutes in a room temperature (70+°F) environment. If the product cannot be powered on, allow it to warm up for 1 hour in a room temperature (70+°F) environment. center to prevent shock.

Q-CAP-D3 MOUNTING OPTIONS

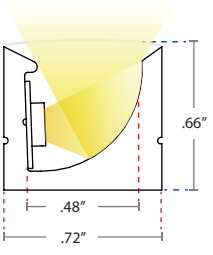
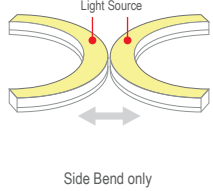
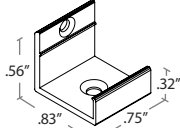
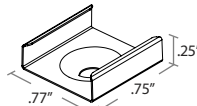
Q-CAP-D3	FLEXIBILITY	CLIPS	FEATURES
		 <p>Aluminum Clips</p>  <p>Stainless Spring Steel Clips</p>	<ul style="list-style-type: none"> • Fully encapsulated with polyurethane • Clear or Translucent • Diode-free result with translucent finish • Superior thermal dissipation • Flexibility: Up to 12" diameter, 6" radius • UV Protected • Indoor & Outdoor applications • Suitable for extreme temperatures • IP68 • UL 676 – Underwater Luminaires and Submersible Junction Boxes • CSA C22 No. 89-15 – Swimming Pool Luminaires, Submersible Luminaires, and Accessories • UL 1598 – Luminaires • UL 2108 – Low Voltage Lighting Systems • UL 8750 – Light Emitting Diodes (LED) Equipment for Use in Lighting • 5 year warranty

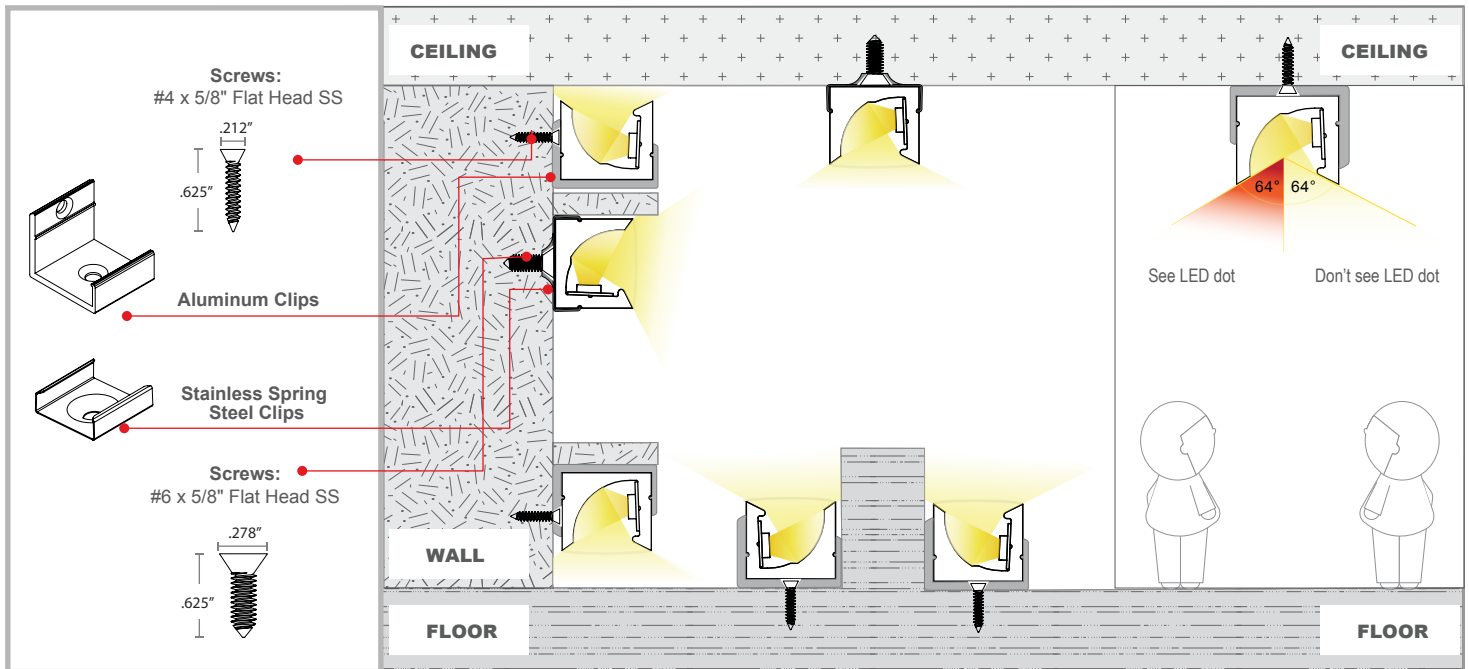

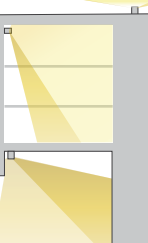
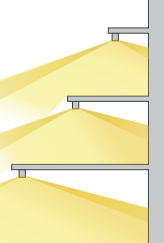
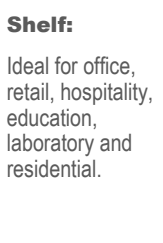
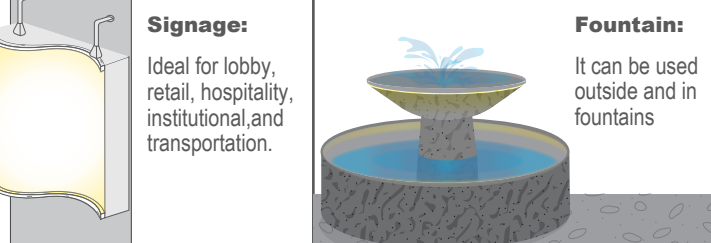
 <p>Display and Under & over cabinet: Ideal for office, retail, hospitality, education, laboratory and residential.</p>	 <p>Shelf: Ideal for office, retail, hospitality, education, laboratory and residential.</p>	 <p>Signage: Ideal for lobby, retail, hospitality, institutional, and transportation.</p>	 <p>Fountain: It can be used outside and in fountains</p>
---	--	---	--

For Cabinet Installations:

• CAUTION: To reduce risk of fires, Do not install in a compartment smaller than 12" x 12" x 12"

Q-CAP-D3 MOUNTING INSTRUCTIONS



• Q-Tran tests all factory soldered leads before shipping to ensure LED is working.

Materials

- Measuring Tape
- Marker
- Q-CAP LEDs
- Screws
- Mounting Clips



Low Voltage Luminaires (Class 2)

- UL 1598 – Luminaires
- UL 2108 – Low Voltage Lighting Systems
- UL 8750 – Light Emitting Diodes (LED) Equipment for Use in Lighting

1 Measuring & Marking

a: Measure and Mark every 2' for wall and Floor Mounting

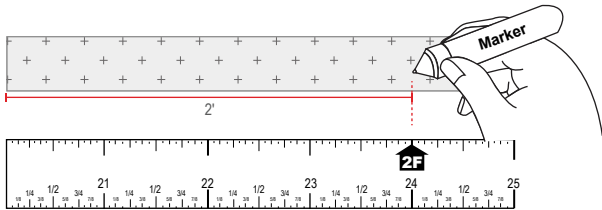

b: Measure and Mark every 1' for ceiling Mounting

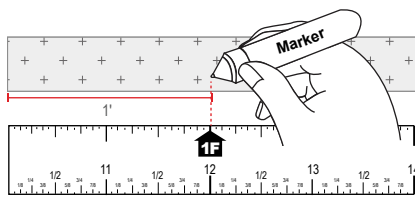

NOTE: Q-CAP product cannot be cut in the field.

2 Secure Q-CAP LEDs to mounting surface

: Secure Mounting Clips to the surface using the provided screws

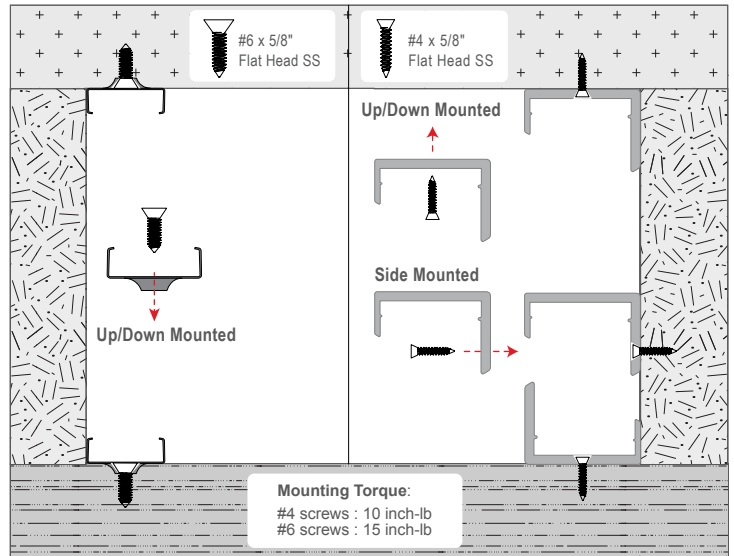

CAUTION: The mounting screws are wood screws and are designed to be mounted to wood studs or wooden frames. If mounting to drywall, additional mounting support may be required, such as a drywall anchor.

3 Clips: Snap Q-CAP LEDs into installed clips.

- a: Aluminum Clips
- b: Stainless Spring Steel Clips

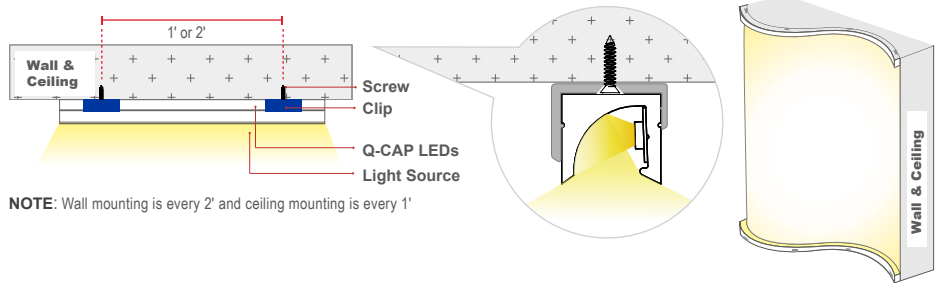

NOTE: Wall mounting is every 2' and ceiling mounting is every 1'

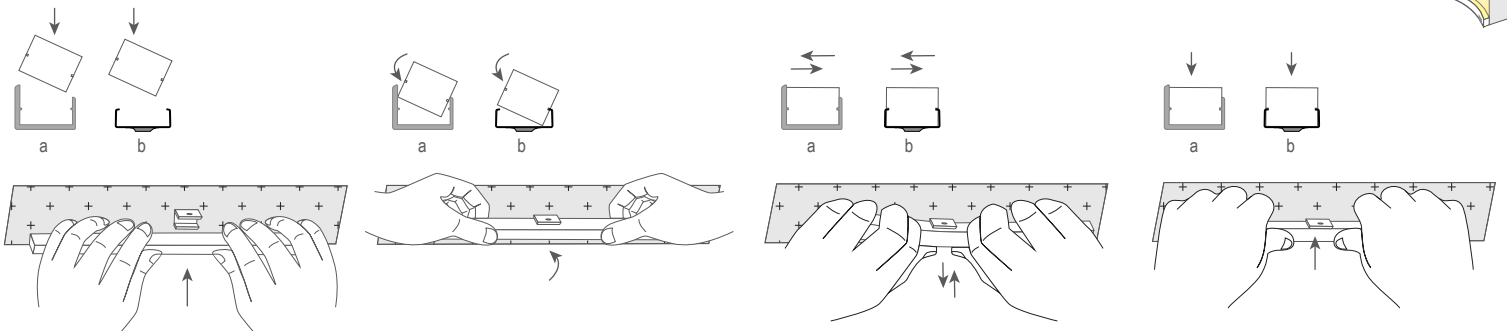

Electronic Driver Non-Dimming

Interior: QTM-eLED

Exterior: QOM-eLED

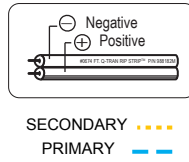
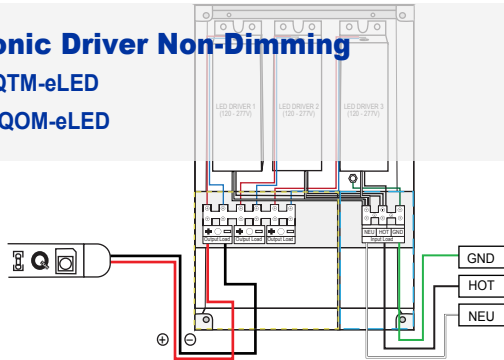

Electronic 0-10V Dimming

Interior: QTM-eLED+0-10V

Exterior: QOM-eLED+0-10V

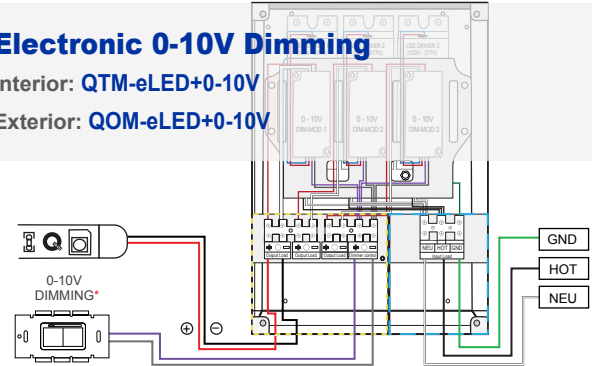

Magnetic without Dimmer

Interior: Q6M-DC+CAP or QTM-DC+CAP

Exterior: QOM-DC+CAP

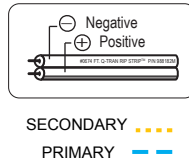
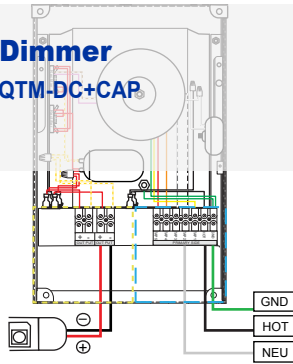

Magnetic with Dimmer

Interior: Q6M-DC+CAP or QTM-DC+CAP

Exterior: QOM-DC+CAP

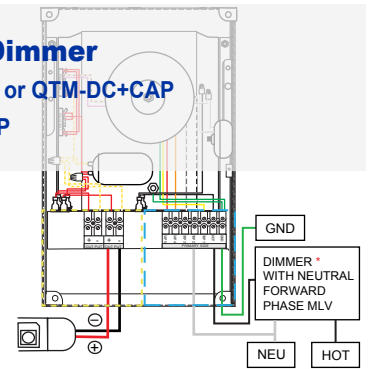

Phase Controlled Dimming

Interior and Exterior: iQ-PH

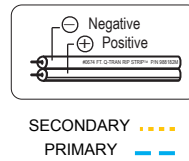
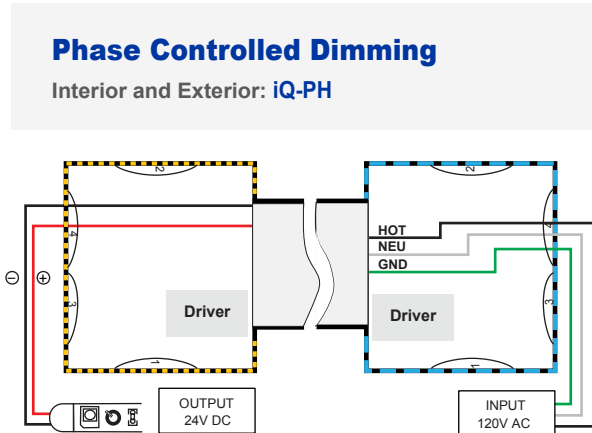

Electronic with 0-10V Dimming options

Exterior: Q-SET-eLED+0-10V

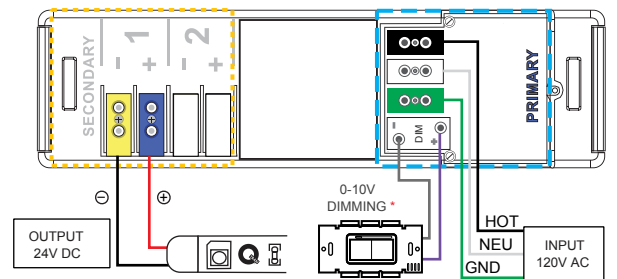

Electronic Power Supplies

Interior: QTM-eLED(E)

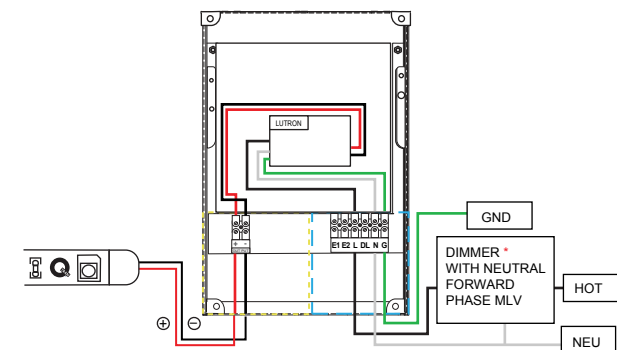
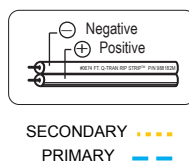
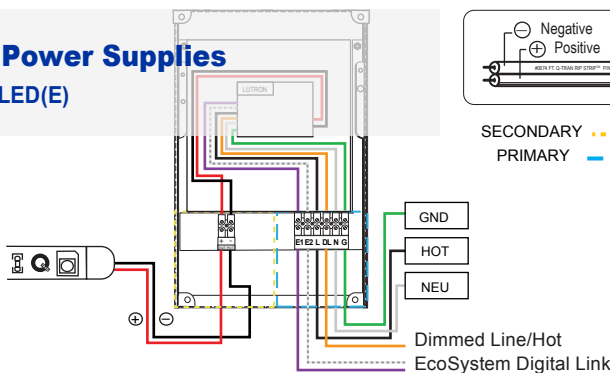

*Customer provided