

Q-VAULT

Installation Instructions



Q-Tran, Inc.
Milford, CT
www.q-tran.com



3426-94 Luminaires - Landscape Lighting Systems - Certified to UL - 1838 Standard.

3425-95 Luminaires - Low Voltage Lighting Systems - Certified to UL - 2108 Standard.



3425-96 Luminaires - Component Hydromassage - Certified to UL - Pool & Spa Standard.



3426-04 Luminaires - Landscape Lighting Systems - Component (including Hydromassage).

3425-15 Luminaires - Low Voltage Lighting Systems.



Q-Tran, Inc.
239924
PATENT PEND.

- FOR SUPPLY CONNECTIONS USE WIRE RATED FOR AT LEAST 90 C
- SUITABLE FOR INGROUND INSTALLATION
- USE DIMMERS RATED FOR MAGNETIC LOW VOLTAGE LOAD
- NOT FOR INSTALLATION TO CONDUIT EXTENDING DIRECTLY TO AN UNDERWATER POOL LIGHT FORMING SHELL.
- SUITABLE FOR USE WITH SUBMERSIBLE LUMINARIES
- SUITABLE FOR INDOOR & OUTDOOR USE
- WARNING: RISK OF FIRE - IF INSTALLATION INVOLVES RUNNING WIRING THROUGH A BUILDING STRUCTURE, SPECIAL WIRING METHODS ARE NEEDED. CONSULT A QUALIFIED ELECTRICIAN.



Q-SET™ LOW VOLTAGE LUMINAIRE POWER SUPPLY

MODEL NUMBER	OUTPUT CLASS	MAX LAMP LOAD	PRIMARY VOLTS	LAMP VOLTS	DIMMER RATING	SEC. BREAKERS	
						12V	24V
QSET-180	CLASS 1	180W	120V/277 (60Hz)	12V/24V	MLV	1X15	1X7.5
QSET-240	CLASS 1	240W	120V/277 (60Hz)	12V/24V	MLV	1X20	1X10
QSET-300	CLASS 1	300W	120V/277 (60Hz)	12V/24V	MLV	1X25	1X12.5
QSET-360	CLASS 1	360W	120V/277 (60Hz)	12V/24V	MLV	2X15	2X7.5
QSET-480	CLASS 1	480W	120V/277 (60Hz)	12V/24V	MLV	2X20	2X10
QSET-600	CLASS 1	600W	120V/277 (60Hz)	12V/24V	MLV	2X25	2X12.5
QSET-540	CLASS 1	540W	120V/277 (60Hz)	12V/24V	MLV	3X15	3X7.5
QSET-720	CLASS 1	720W	120V/277 (60Hz)	12V/24V	MLV	3X20	3X10
QSET-900	CLASS 1	900W	120V/277 (60Hz)	12V/24V	MLV	3X25	3X12.5
QSET-ELED-60	CLASS 2	1X60=60W	120-277 (50/60Hz)	12V	NO	12V	-
QSET-ELED-120	CLASS 2	2X60=120W	120-277 (50/60Hz)	12V	NO	12V	-
QSET-ELED-60/0-10	CLASS 2	1X60=60W	120-277 (50/60Hz)	12V	0-10	12V	-
QSET-ELED-120/0-10	CLASS 2	2X60=120W	120-277 (50/60Hz)	12V	0-10	12V	-
QSET-ELED-100	CLASS 2	1X100=100W	120-277 (50/60Hz)	24V	NO	-	24V
QSET-ELED-200	CLASS 2	2X100=200W	120-277 (50/60Hz)	24V	NO	-	24V
QSET-ELED-100/0-10	CLASS 2	1X100=100W	120-277 (50/60Hz)	24V	0-10	-	24V
QSET-ELED-200/0-10	CLASS 2	2X100=200W	120-277 (50/60Hz)	24V	0-10	-	24V
QSET-MLED-60	CLASS 1	60W	120 (60Hz)	12V	MLV	12V	-
QSET-MLED-120	CLASS 1	120W	120 (60Hz)	12V	MLV	12V	-
QSET-MLED-180	CLASS 1	180W	120 (60Hz)	12V	MLV	12V	-
QSET-MLED-100	CLASS 1	100W	120 (60Hz)	24V	MLV	-	24V
QSET-MLED-200	CLASS 1	200W	120 (60Hz)	24V	MLV	-	24V
QSET-MLED-300	CLASS 1	300W	120 (60Hz)	24V	MLV	-	24V



CSA LISTINGS

QSET-180
 QSET-240
 QSET-300
 QSET-360
 QSET-480
 QSET-600
 QSET-540
 QSET-720
 QSET-900

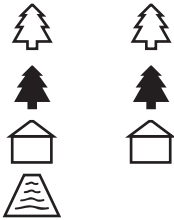

QSET-ELED-60
 QSET-ELED-120
 QSET-ELED-60/0-10
 QSET-ELED-120/0-10
 QSET-ELED-100
 QSET-ELED-200
 QSET-ELED-100/0-10
 QSET-ELED-200/0-10



QSET-MLED-60
 QSET-MLED-120
 QSET-MLED-180
 QSET-MLED-100
 QSET-MLED-200
 QSET-MLED-300



OUTDOOR Under 15 Volts = LV Wire Burried 0" to 6"



LANDSCAPE

Outdoor Landscape Lighting - Under 15 Volts
 CSA Certified for both the U.S. and Canada to the UL-1838 Standard for Landscape Lighting with in-ground enclosure and component power supply operating at less than 15V. This listing allows for the LV Q-WIRE to be installed 0" to 6" underground.



POOL & SPA

Pool & Spa - Under 15 Volts
 CSA Certified for the U.S. to the UL-Pool & Spa Power Supply Standard. This listing is intended for power supplies used to power fountain, swimming pool and spa luminaires operating at less than 15V.

OUTDOOR 15 to 30 Volts = LV Wire burried 18"



LANDSCAPE

Outdoor Landscape Lighting - 15 to 30 Volts
 CSA Certified for both the U.S. and Canada to UL-2108 Standard with a listing of "Low Voltage Luminaire Power Supply" for lamps operating at 12 or 24 volts where the secondary voltage is between 15 to 30 volts. Please note that the secondary wiring must be installed 18" below grade per the N.E.C.

INDOOR LV Lighting under 30 Volts



INDOOR

Indoor Open Conductor Systems - Under 30V
 CSA Certified for both the U.S. and Canada to UL-2108 Standard as a "Low Voltage Luminaire Power Supply" for lamps operating at 12V or 24V allows for live conductor lighting equipment mounted above 7 feet and other types of LV Lighting equipment, per N.E.C. Article 411.

Q-VAULT™ 120V (60Hz) - 12V

FOR CONDUIT CONNECTION

“WARNING - RISK OF SHOCK. Install power unit 5 feet (1.5 m) or more from the pool or spa and 10 feet (3.05 m) or more from a fountain. Where the power unit is installed within 10 feet (3.05 m) of a pool or spa, connect unit to GFCI protected branch circuit.”

FOR POWER SUPPLY CORD CONNECTION

“WARNING - RISK OF SHOCK. Installed power unit 5 feet (1.5M) or more from the pool, spa, or fountain. Where the power unit is installed (a) indoors within 10 feet (3.05) of a pool, spa, or fountain or (B) outdoors, connect power unit to a receptacle protected by a GFCI”.

“WARNING - RISK OF FIRE. If installation requires running wire through a building structure, special wiring methods are needed. Contact a qualified electrician.

“WARNING - Outdoor Cord-connected unit shall be connected to a GFCI protected hooded flush type cover plate receptacle marked “Wet Location”.

“WARNING - Do not use extension cords

The main Secondary Wiring is intended for shallow burial - less than 6 inches (152 mm)

For Supply connections use wire rated for at least 60C.

SUITABLE FOR INDOOR / OUTDOOR USE

**SUITABLE FOR USE WITH SUBMERSIBLE LUMINAIRES
OR SUBEMERSIBLE PUMPS**

**SUITABLE FOR USE WITH LOW VOLTAGE
LANDSCAPE LUMINAIRES / FITTINGS**

Q-VAULT™ 277V (60Hz) - 12V

“WARNING - RISK OF SHOCK. Install power unit 5 feet (1.5 m) or more from the pool or spa and 10 feet (3.05 m) or more from a fountain. Where the power unit is installed within 10 feet (3.05 m) of a pool or spa, connect unit to GFCI protected branch circuit.”

“WARNING - RISK OF FIRE. If installation requires running wire through a building structure, special wiring methods are needed. Contact a qualified electrician.

The main Secondary Wiring is intended for shallow burial - less than 6 inches (152 mm)

For Supply connections use wire rated for at least 60C.

SUITABLE FOR INDOOR / OUTDOOR USE

**SUITABLE FOR USE WITH SUBMERSIBLE LUMINAIRES
OR SUBEMERSIBLE PUMPS**

**SUITABLE FOR USE WITH LOW VOLTAGE
LANDSCAPE LUMINAIRES / FITTINGS**

Contact your local Distributor or Q-Tran for Q-Wire,
Q-Click or proper Accessory Kit

Q-VAULT™ & Q-SET™ INSTALLATION GUIDE

ROUGH IN WIRING

STEP 1:

Excavate a 14" x 30" x 16" Deep hole for the Q-VAULT direct burial housing.

STEP 2:

Dig trenches for primary & secondary wiring to Q-VAULT housing location.

STEP 3: * Drain pipe is additional. Call factory for pricing.

Place drain pipe at a 30 degree angle at the lowest slope of land for proper drainage. Fill bottom of pit with 4" of gravel.

SEE DIAGRAM A

STEP 4:

Bring all primary and secondary wiring into housing.

A: Entry location is provided at both the bottom and side of the Junction Box located on the Q-VAULT housing.

B: On the bottom of Junction Box there are: **(4) 3/4" NPT and (2) 1/2" NPT KO's.**
SEE DIAGRAM B

C: Using the Field Drill Guide Labels provided in the installation kit you are able to drill for various fitting sizes.

SEE DIAGRAM C

Note: For complete water tight guarantee, use Q-Tran's Q-Clk fittings and Q-Wire stranded wire. Warranty is void if these components are not used.

Note: Primary leads should be 12" min. Secondary leads should be 24" min.

STEP 5:

After all field wiring has been installed with proper lead lengths, tighten all fittings properly to assure they are water proof.

Note: Label all wiring for future reference.

STEP 6:

Coil and store field wiring in Junction Box area.

* Drain pipe is additional. Call factory for pricing.

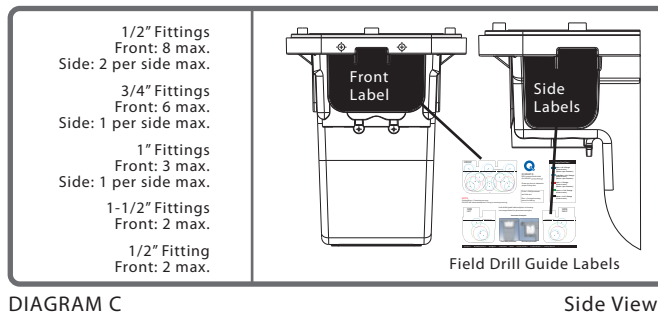
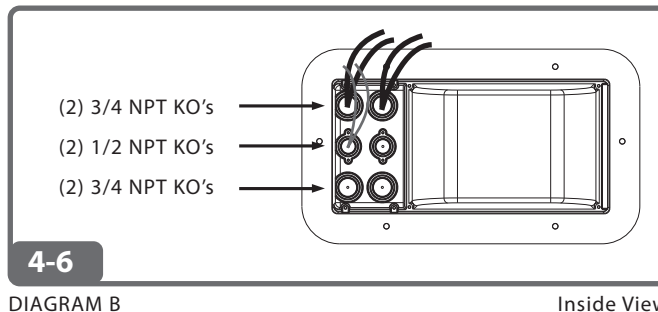
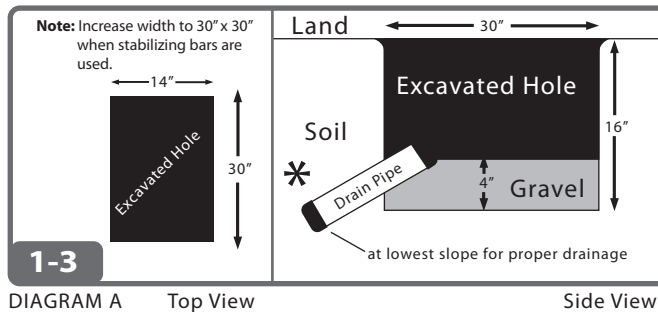

Q-VAULT™ & Q-SET™ INSTALLATION GUIDE

ROUGH IN WIRING

STEP 7:

Clean top perimeter of housing prior to installing gasket.
SEE DIAGRAM D

STEP 8:

Install door and tighten the 6 door bolts in the number sequence shown.
SEE DIAGRAM E

Note: A screw driver or nut driver can be used to get bolts seated before final tightening. Proper door bolt tightening must be done with a ratchet wrench using a 3/8" socket at a maximum torque of 50"lbs.

STEP 9:

Attach the provided Support Bars to the Q-VAULT housing using the 6-32 X 5/8 screws.
SEE DIAGRAM F

*OPTIONAL: Concrete Pour Ring Nut & Bolt Installation. SEE DIAGRAM G

STEP 10:

Level housing and fill hole with gravel to 4" of surface. Add soil to grade.
SEE DIAGRAM H

* Drain pipe is additional. Call factory for pricing.

Note: Gasket only fits one way. Gasket easily slides over vault posts. If you are having to force the gasket, it is backwards. (Gasket must sit on top of vault. No portion should be overhanging.)

7

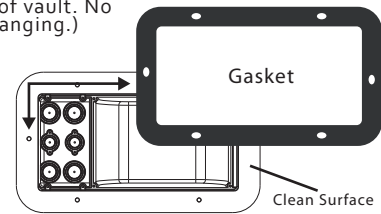
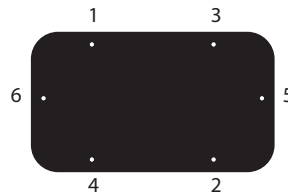

DIAGRAM D

Top View

Top View of Q-VAULT housing door



8

Maximum torque 50"lbs.

DIAGRAM E

Top View

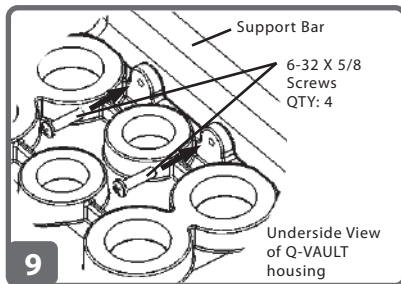

9

DIAGRAM F

Bottom View

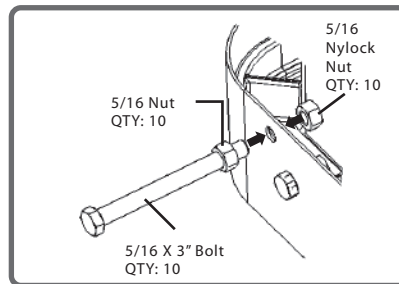
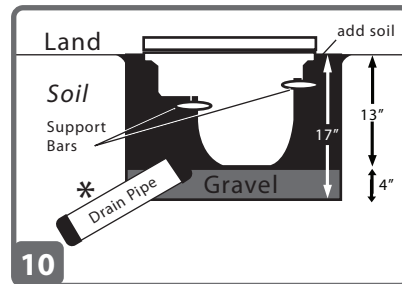

DIAGRAM G



10

DIAGRAM H

Side View

Q-VAULT & Q-SET INSTALLATION GUIDE

Installing Q-SET L.V. Luminaire Power Supply

Step 11:

Remove cover if installed, be sure to store cover and cover gasket in a clean and dry location.

Step 12:

Move field wiring out of the way.

Step 13:

Place Q-SET low voltage luminaire power supply cassette into the Q-VAULT housing using the support flaps. The cassette's primary junction box should be placed next to field wiring junction box located on the housing.

SEE DIAGRAM I

Primary Connections

Step 14:

- Landscape Lighting: Bring primary field wiring directly into the Cassette's primary junction box through open hole.

- Pool & Spa: Bring primary field wiring through the P&S sleeving. Do not screw base fitting to field junction box until re-enterable potting is complete. SEE DIAGRAM J. Call Q-Tran (203-367-8777) if P&S sleeving is needed.

Primary Connections:

- Ground to Green terminal
- Neutral to White terminal
- Hot to either: Tap1 - No Dimmer / Tap2 - With Dimmer

A: For proper connection to terminal block, use the Strip Length Guide on the primary junction box cover of the Cassette. Determine the strip length approximately 1".

B: Using supplied hex key unscrew wire(s) and hand tighten the (2) 1/4-28 316ss set screws.

C: Fully insert the properly stripped wire(s) and hand tighten both set screws with provided hex key. Do Not use a ratchet wrench. Maximum torque = 30"lbs. SEE DIAGRAM K

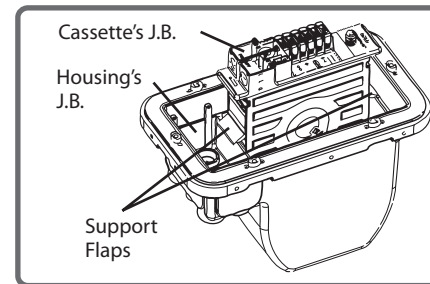

DIAGRAM I

Isometric View

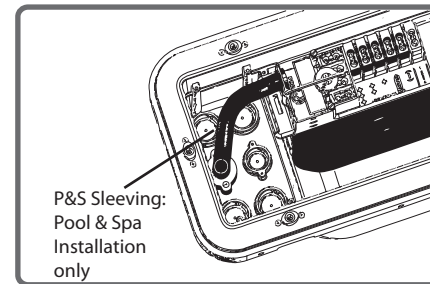

DIAGRAM J

Top View

Note: See page 8 for re-enterable potting steps.

Terminal Capacity Solid or Stranded

- 7 - #14 AWG Wires
- 5 - #12 AWG Wires
- 4 - #10 AWG Wires
- 2 - #8 AWG Wires

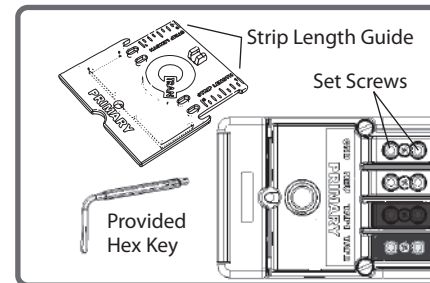

DIAGRAM K

Top View

Q-VAULT™ & Q-SET™ INSTALLATION GUIDE

STEP 15:

Determine proper lengths and trim to correct length.

STEP 16:

L.V. Common: Is connected to a yellow terminal block which is internally wired to a secondary breaker.

Step 17:

L.V. Line: Is connected to 1 of the 5 taps.

Note: Unless the proper tap is known, always connect to the terminal marked **START**.

Note: For multiple secondary runs repeat steps.

Step 18:

Upon completion of all field wiring lift cassette up slightly to allow support flaps to drop and lower cassette into the housing.

Step 19:

Using wire ties provided secure field wiring to cassette using the slots provided on the primary junction box cover and junction box sides.

SEE DIAGRAM L

Step 20:

Secure primary junction box cover and store hex key.

SEE DIAGRAM M

Step 21: (Potting Field Connections)

First properly locate all field wiring inside the junction box where it will be permanently positioned.

SEE DIAGRAM N

SIMPLE AS: ① ② ③

SEE NEXT PAGE

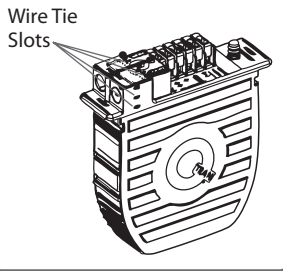

DIAGRAM L

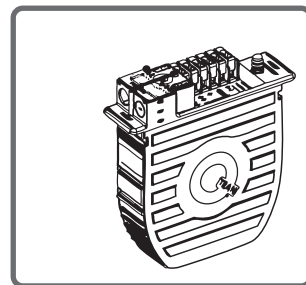
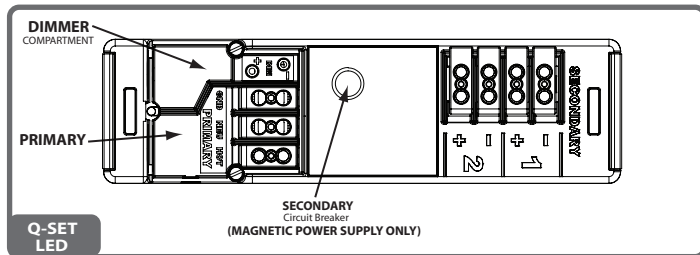
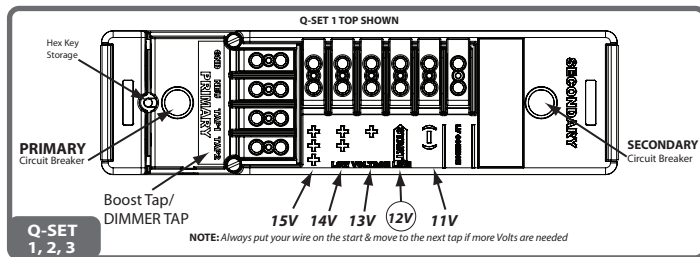

DIAGRAM M



Q-VAULT™ & Q-SET INSTALLATION GUIDE

SIMPLE AS: ① ② ③

① Use putty provided to seal wires in potting well. It is important that the well is liquid tight so that when the re-enterable epoxy is poured, it does not escape out the bottom. Be sure the putty is put into the very bottom of the well to allow ample room for the epoxy.

SEE DIAGRAM O

② A: The 3M-8882 re-enterable epoxy takes several hours to set. When set it will form a into a water tight “jello” consistency.

B: Mix the two part epoxy together per 3M instructions located on the epoxy packaging.

C: Push all the mixed epoxy together to one end of the bag. Cut the bag in half.

③ A: Using the syringe pull the mixed epoxy into the syringe by pulling the plunger out slowly.

B: Slowly dispense the mixed epoxy from the syringe into the utilized potting wells. SEE DIAGRAM P

Note: Potting is now complete

Step 22: (Final Door Installation)

- Clean housing area where door gasket will rest
- Install a clean door gasket.

LAST
STEP

Just before door is installed put velcro desiccant bag in place. Attach the two velcro loop coins on the desiccant bag to the two velcro hook coins on the underside of the housing door. SEE DIAGRAM Q

Note: Install door and tighten the 6 door bolts at a maximum torque of 50”lbs. Door bolt tightening must be done with a ratchet wrench using a 3/8” socket.

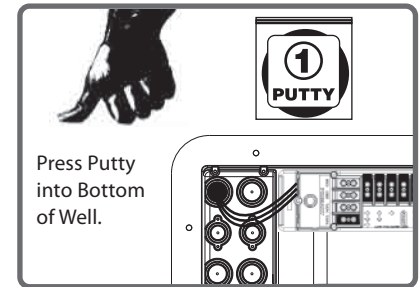

DIAGRAM O

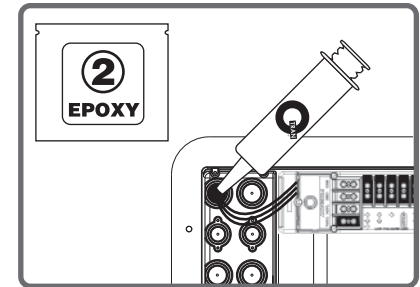

DIAGRAM P

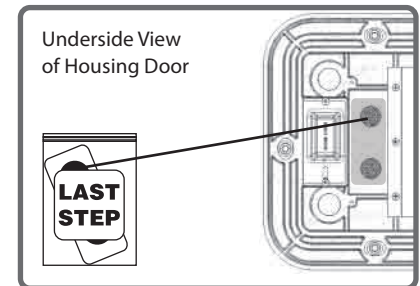

DIAGRAM Q

