



LED INSTALLATION INSTRUCTION iQ54 Damp Rated

Please read all instructions prior to installation and keep for future reference.

1. Product should be installed by a qualified electrician.
2. Prior to installation ensure power is off at the power supply center to prevent shock.
3. Use Q-Tran power supplies.
4. Suitable for Dry & Damp Locations.
5. Temp Rating: -4 degree to +113 °F.



- Q-Tran tests all factory soldered leads before shipping to ensure LED is working.
- Thoroughly clean the area where the tape light is to be installed.

Materials
• LED Tape light
• Screws
• Mounting Clips
• Mounting Straps

NOTE: Q-Tran offers a full line of mounting extrusions / channels.

iQ54

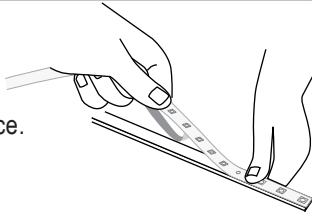

Remove the backing from the adhesive and apply firm pressure to the bonding surface. Do not remove more of the backing than is needed, this allows for dust and debris to contaminate the adhesive. The smallest amount of exposed adhesive is the best case.

*For LED application instructions please review the Applying LEDs using adhesive section on pages 2 and 3.

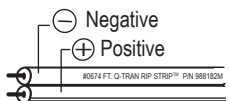

LED Tape Light : Wire lead can be trimmed to length as needed

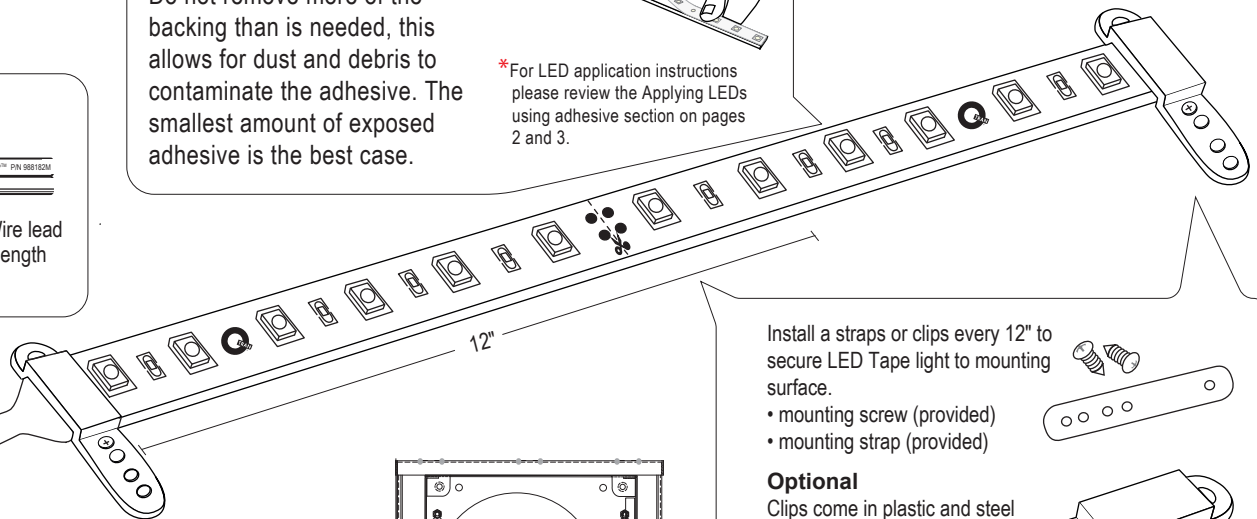

Install a straps or clips every 12" to secure LED Tape light to mounting surface.

- mounting screw (provided)
- mounting strap (provided)

Optional
Clips come in plastic and steel (see LED Tape Light brochure for other clips type)

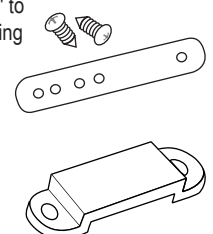

Q-TRAN Power Supply

Always ensure power to power supply is off! Follow diagram below to connect power feed wires to power supply. Refer to Q-Tran power supply instructions for wiring information line voltage side.

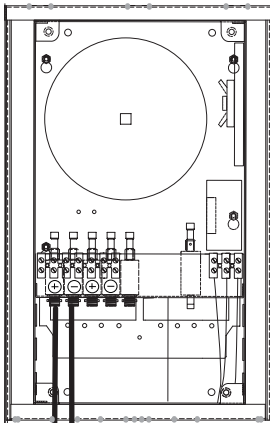

NOTE: Always test LED operation before installing. Connect LED to power supply to ensure it is working properly and all non factory soldered connections are secure.

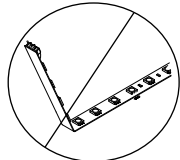
- Avoid bending tapelight in sharp horizontal angles which may damage the LEDs.
- Field modifications are not covered by Q-Tran warranty.



iQ54 LED INSTALLATION INSTRUCTION

Surface Preparation

Please read all instructions prior to installation and keep for future reference.

1. Product should be installed by a qualified electrician.
2. Prior to installation ensure power is off at the power supply center to prevent shock.
3. Use Q-Tran power supplies.
4. Suitable for Dry Locations.
5. Temp Rating: -4 degree to +113 °F.



- Q-Tran tests all factory soldered leads before shipping to ensure LED is working.
- Thoroughly clean the area where the tape light is to be installed.

Materials
<ul style="list-style-type: none"> • LED Tape light • Primer 94 • 50/50 alcohol

NOTE: Q-Tran offers a full line of mounting extrusions / channels.

Surface preparation

- 1 Temperature and environmental concerns:
 - a. Ideal application environment is 70-100°F in 50% humidity
 - b. Absolute Minimum temperature : 50°F
 - c. This temperature and humidity should be maintained for 72 hours after application for maximum holding force

- 2 Thoroughly clean the area where tape lights will be installed. Using a 50/50 alcohol mix, clean the area where LEDs will be applied and allow time for alcohol to dry, roughly 5 minutes.

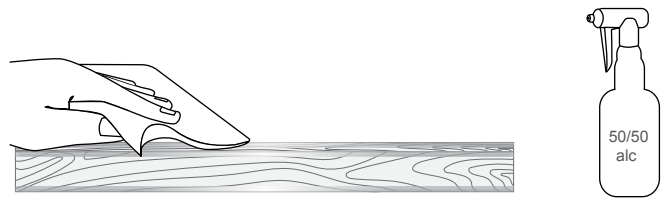

- 3 For porous materials (Wood, Brick, Concrete) apply two layers of paint or primer to the surface. This will help create a better bonding surface for these materials. This can be purchased from local hardware store.

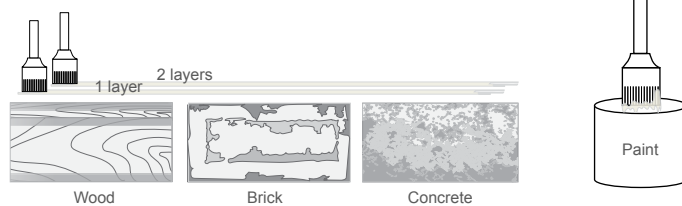

- 4 Apply 3M Primer 94 to surface where LED tape lights will be installed to increase bonding power. Allow time for Primer 94 to dry, roughly 5 minutes at room temperature. A second coat can be applied once first coat has dried. For best results with a porous material, apply the paint as described in step 3 and two layers of Primer 94.

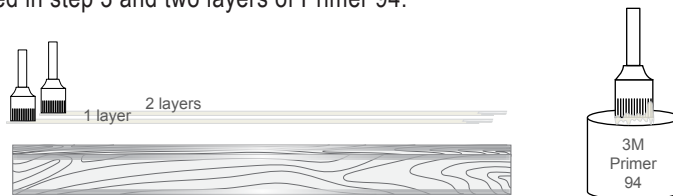

NOTE: Always test LED operation before installing. Connect LED to power supply to ensure it is working properly and all non factory soldered connections are secure.

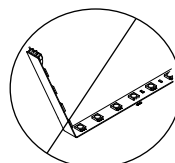

- Avoid bending tapelight in sharp horizontal angles which may damage the LEDs.
- Field modifications are not covered by Q-Tran warranty.



iQ54 LED INSTALLATION INSTRUCTION

Applying The LEDs

Please read all instructions prior to installation and keep for future reference.

1. Product should be installed by a qualified electrician.
2. Prior to installation ensure power is off at the power supply center to prevent shock.
3. Use Q-Tran power supplies.
4. Suitable for Dry Locations.
5. Temp Rating: -4 degree to +113 °F.

- Q-Tran tests all factory soldered leads before shipping to ensure LED is working.
- Thoroughly clean the area where the tape light is to be installed.

Materials
<ul style="list-style-type: none"> • LED Tape light • Mounting clips • Epoxy

NOTE: Q-Tran offers a full line of mounting extrusions / channels.

Applying the LEDs

- 1** Remove the backing from the adhesive and apply firm pressure to the bonding surface. Do not remove more of the backing than is needed, this allows for dust and debris to contaminate the adhesive. The smallest amount of exposed adhesive is the best case.

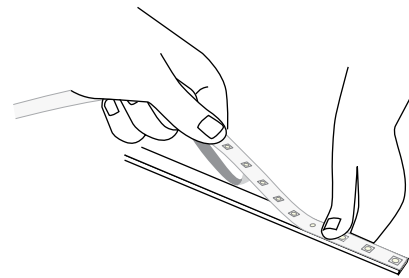

- 2** For improved bonding performance, apply small amounts of epoxy at each end to increase holding force. Refer to table below for suggested epoxies. All are available from local hardware store.

Materials	Suggested Epoxies
Concrete, Stone, Cinderblock, Metal and Brick	Loctite Metal and Concrete Two-Part Epoxy
ABS, Fiberglass, Plastic and PVC	Loctite Plastic Two-Part Epoxy
Tile, Wood, Ceramic, Glass, or Metal	Loctite Clear Two-Part Epoxy
All Purpose	Strong Stik

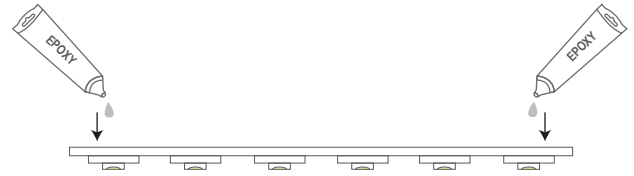

- 3** Install clips if they are being used.

Install a strap every 12" to secure LED Tape light to mounting surface.

- mounting screw (provided)
- mounting strap (provided)

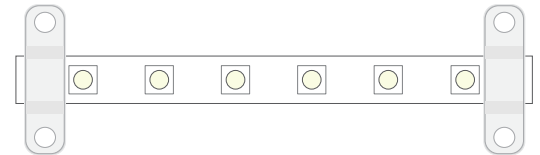
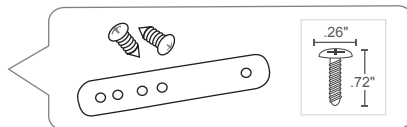

- 4** Allow the adhesive to bond for up to 72 hours.

NOTE: Always test LED operation before installing. Connect LED to power supply to ensure it is working properly and all non factory soldered connections are secure.

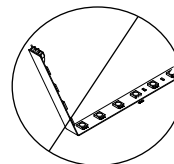

- Avoid bending tapelight in sharp horizontal angles which may damage the LEDs.
- Field modifications are not covered by Q-Tran warranty.



iQ54 LED INSTALLATION INSTRUCTION

Cutting - Lead Wire & Jumper

Please read all instructions prior to installation and keep for future reference.

1. Product should be installed by a qualified electrician.
2. Prior to installation ensure power is off at the power supply center to prevent shock.
3. Use Q-Tran power supplies.
4. Suitable for Dry Locations.
5. Temp Rating: -4 degree to +113 °F.



- Q-Tran tests all factory soldered leads before shipping to ensure LED is working.
- Thoroughly clean the area where the tape light is to be installed.

Materials

- LED Tape light
- Measuring Tape
- Scissors
- Heat Gun

NOTE: Q-Tran offers a full line of mounting extrusions / channels.

1 Measuring & Cutting

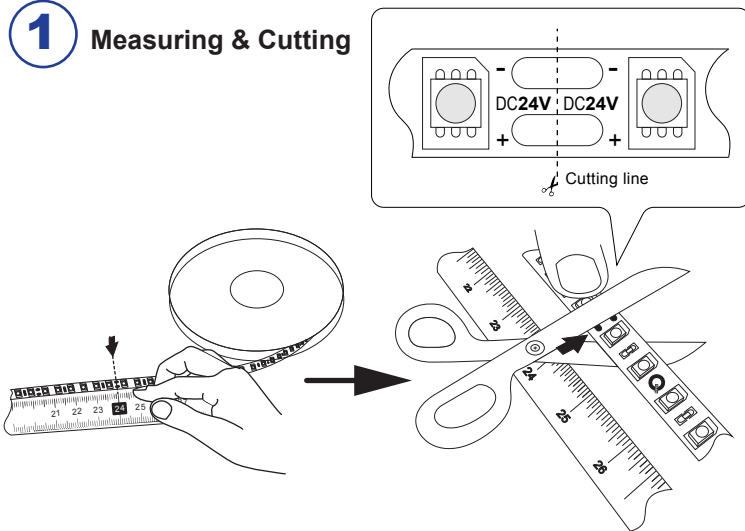

2 Solder lead wire onto terminal

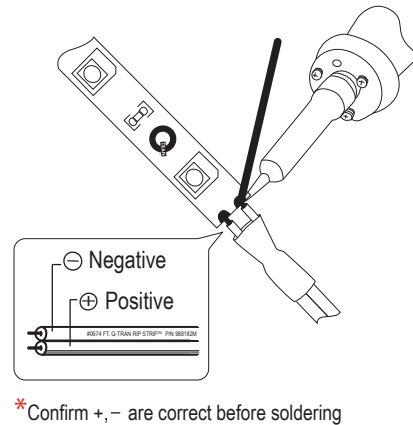

Items includes (Lead Wire)

- (1) 18" Lead wire
- (1) 6" Solder
- (1) 1" Shrink Tube
- (1) 1/2" Shrink Tube

Items includes (Jumper)

- (1) 6" Lead wire
- (1) 6" Solder
- (2) 1" Shrink Tube
- (2) 1/2" Shrink Tube

3 Place shrink tube. Steps 1 - 5

4 For jumper : repeat step 2 and 3

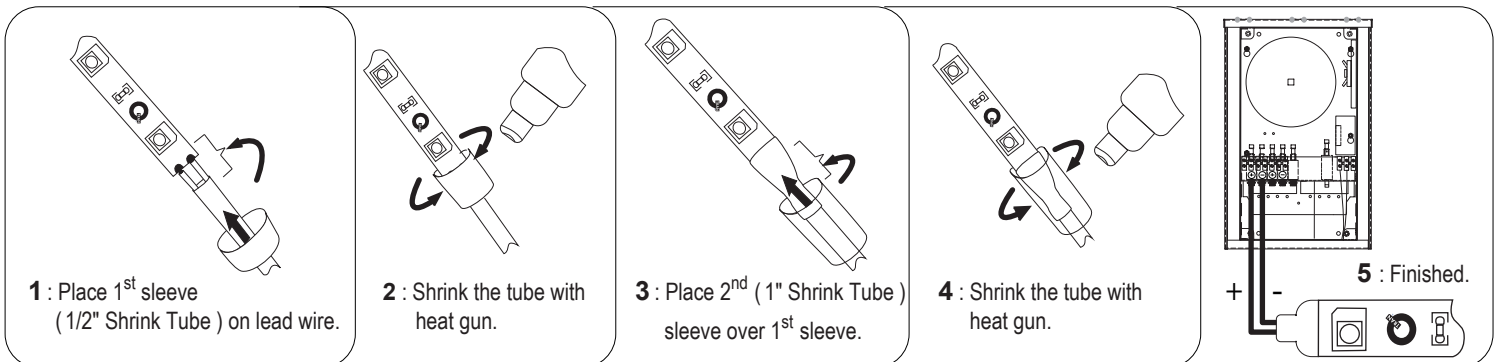

NOTE: Always test LED operation before installing. Connect LED to power supply to ensure it is working properly and all non factory soldered connections are secure.

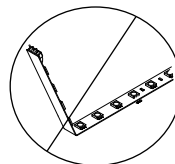

- Avoid bending tapelight in sharp horizontal angles which may damage the LEDs.
- Field modifications are not covered by Q-Tran warranty.



iQ54 RGB LED INSTALLATION INSTRUCTION

CUTTING - LEAD WIRE & JUMPER

Please read all instructions prior to installation and keep for future reference.

1. Product should be installed by a qualified electrician.
2. Prior to installation ensure power is off at the power supply center to prevent shock.
3. Use Q-Tran power supplies.
4. Suitable for Dry Locations.
5. Temp Rating: -4 degree to +113 degree.

*Q-Tran offers a full line of mounting extrusions / channels.



- Q-Tran tests all factory soldered leads before shipping to ensure LED is working.
- Thoroughly clean the area where the tape light is to be installed.

Materials

- LED Tape light
- Measuring Tape
- Scissors
- Heat Gun

1 Measuring & Cutting

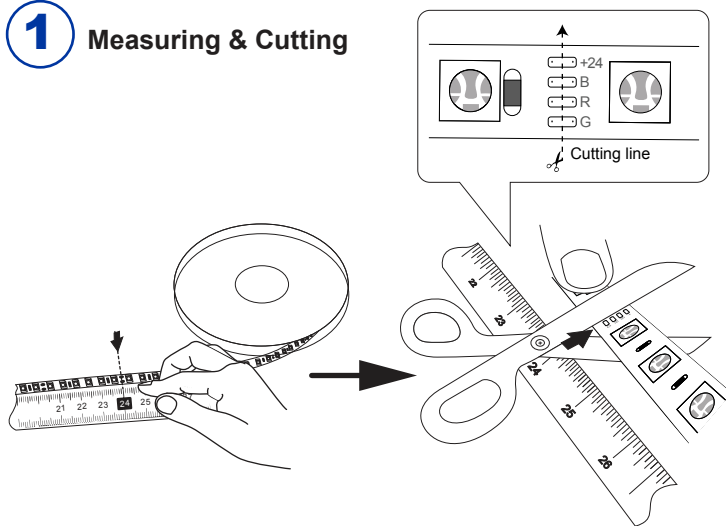

2 Solder lead wire onto terminal

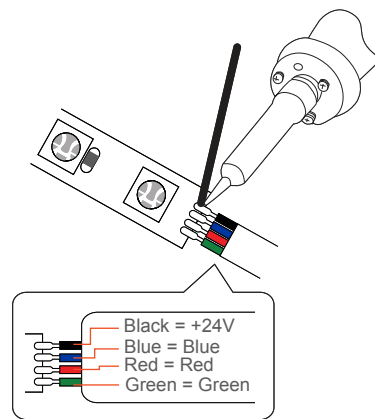

Items includes (Lead Wire)

- (1) 18" Lead wire
- (1) 6" Solder
- (1) 2" Shrink Tube
- (1) 1" Shrink Tube

Items includes (Jumper)

- (1) 6" Lead wire
- (1) 6" Solder
- (2) 2" Shrink Tube
- (2) 1" Shrink Tube

3 Place shrink tube. Steps 1- 4

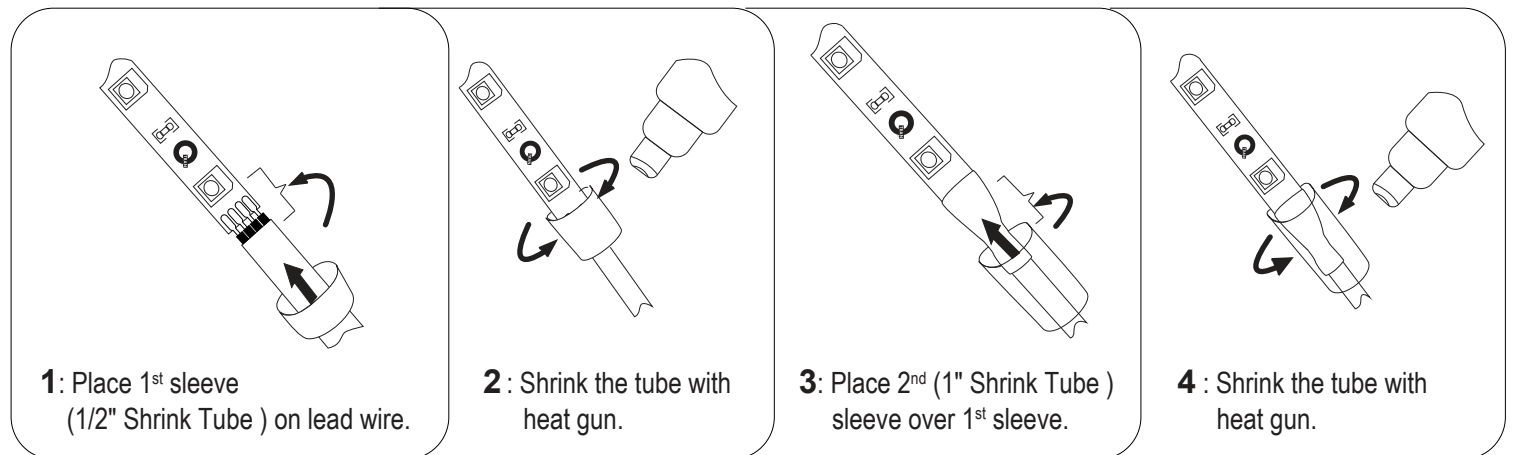

4 For jumper : repeat step 2 and 3

NOTE: Always test LED operation before installing. Connect LED to power supply to ensure it is working properly and all non factory soldered connections are secure.

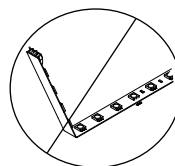

• Avoid bending tapelight in sharp horizontal angles which may damage the LEDs.



LED INSTALLATION INSTRUCTION

LED / Extrusion Assembly

Please read all instructions prior to installation and keep for future reference.

Temperature and environmental concerns:

- Ideal application environment is 70-100°F in 50% humidity
- Absolute Minimum temperature : 50°F
- This temperature and humidity should be maintained for 72 hours after application for maximum



- Q-Tran tests all factory soldered leads before shipping to ensure LED is working.
- Thoroughly clean the area where the tape light is to be installed.

Materials

- LED Tape Light
- VHB Tape
- Extrusion Lens
- End Cap
- Krazy Glue

1 Clean the surface before applying:

Thoroughly clean the area where tape lights will be installed. Using a 50/50 alcohol mix, clean the area where LEDs will be applied and allow time for alcohol to dry, roughly 5 minutes.

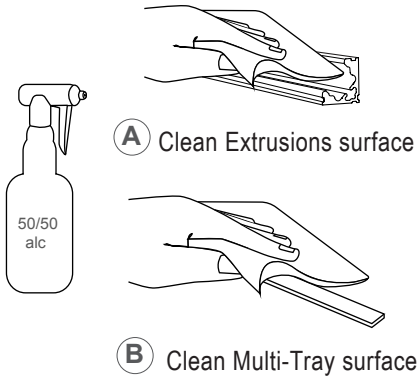

2 Gently place LED in extrusion/Tray:

Apply firm pressure to the bonding surface. Do not remove more of the backing than is needed, this allows for dust and debris to contaminate the adhesive. The smallest amount of exposed adhesive is the best case.

NOTE: Non Multi-Tray extrusions used step A

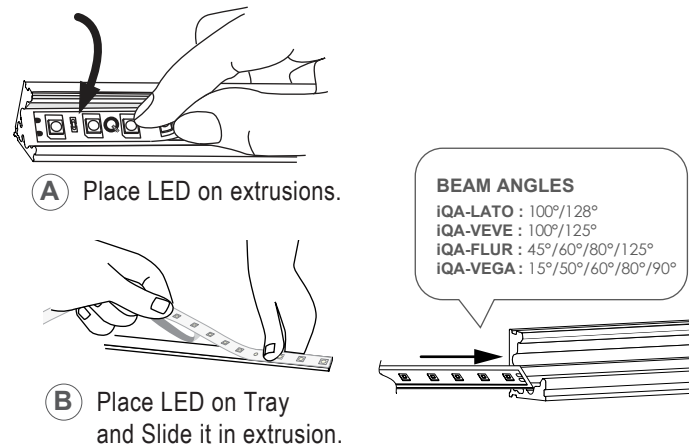

3 Snap lens in extrusion to protect tape light:

Start applying uniform pressure until the two panels (extrusion & Lens) snap securely together.

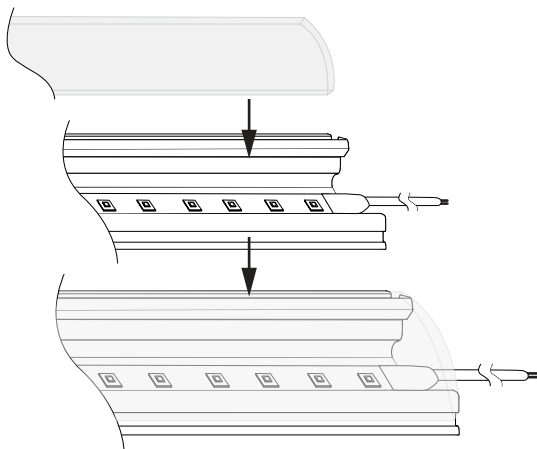

4 Secure End Cap in place:

Add Krazy Glue inside the cap and glue around to secure End Cap in place.

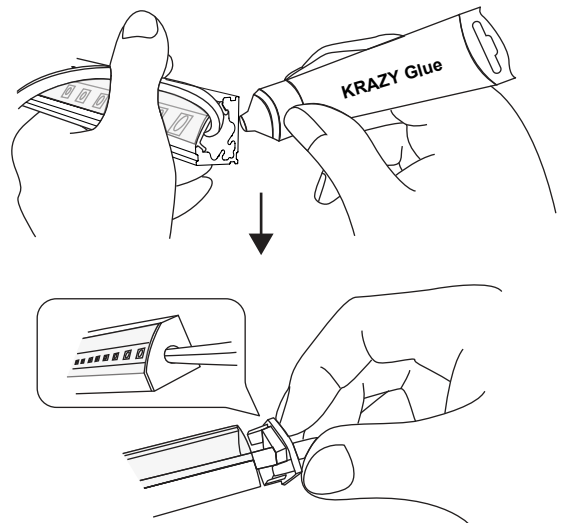



LED INSTALLATION INSTRUCTIONS

Mounting Clips



- Q-Tran tests all factory soldered leads before shipping to ensure LED is working.
- Thoroughly clean the area where the tape light is to be installed.

Materials	
• Measuring Tape	• Screws
• Marker	• Clips

EXTRUSIONS	CLIPS	EXTRUSIONS	CLIPS	EXTRUSIONS	CLIPS
iQA-LATO iQA-FLUR iQA-VEVE		iQA-WIDE		iQA-SLIM	
iQA-45DW-RD iQA-45DW-90		iQA-SQR		iQA-VEGA	
				iQA-ROND	

1 **Measuring & Marking where the clips being used:**
 Measuring & Marking every 12" to secure the clips to mounting surface.

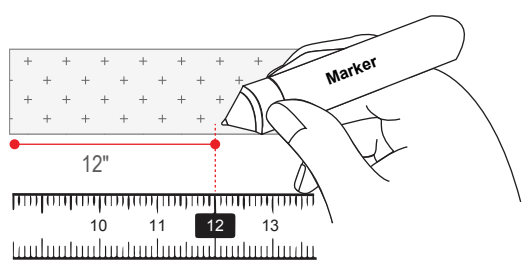

2 **Secure LED Tape light to mounting surface:**
 mounting screw (#4 x 5/8" Flat Head SS) are provided

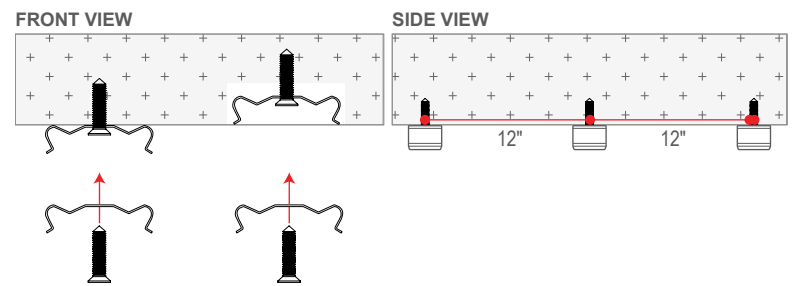

NOTE: Mounting clips are provided with each 8ft length of extrusion.

3 **Clips:** Snap extrusion into installed clips.

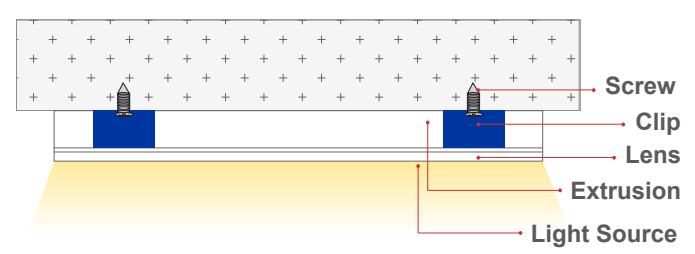
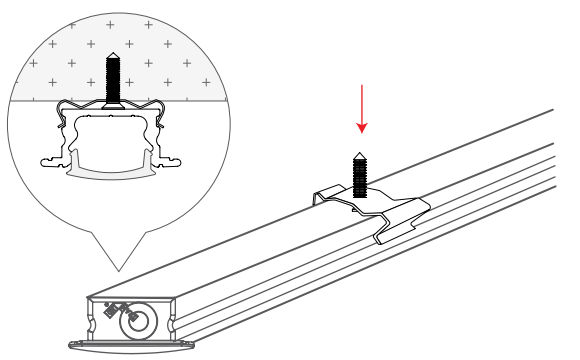



LED INSTALLATION INSTRUCTIONS

Mounting Options



- Q-Tran tests all factory soldered leads before shipping to ensure LED is working.
- Thoroughly clean the area where the tape light is to be installed.

Materials	
• VHB Foam Tape	• Screws
• Strong Stik	• Clips

Mounting Options

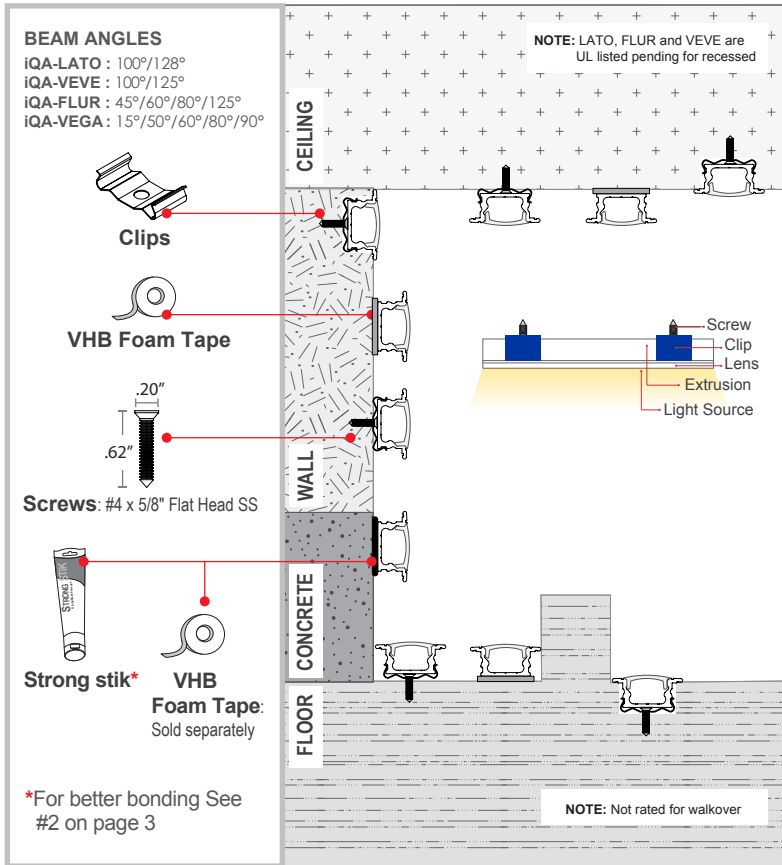

Cove, Under & over cabinet:

Ideal for office, retail, hospitality, education, laboratory and residential.

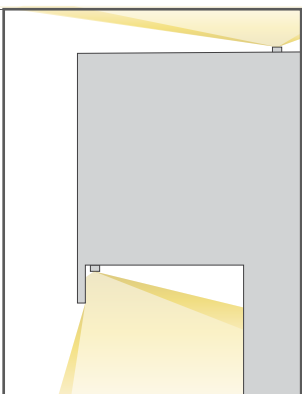

Shelf:

Ideal for office, retail, hospitality, education, laboratory and residential.

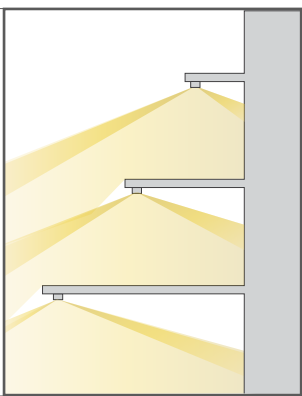

Display cabinet:

Ideal for retail and hospitality.

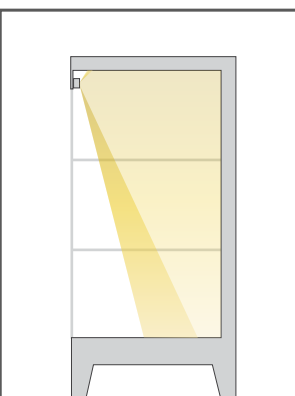

Signage:

Ideal for lobby, retail, hospitality, institutional, and transportation.

